

80ns, Low-Power, RRIO, High-Speed Comparators

FEATURES

- **Low Power Consumption:** 160 μ A (TYP)
- **Wide Supply Voltage:** 2.7V to 5.5V
- **Fast Response:** 80ns Propagation Delay with 100mV Overdrive
- **Input Common-Mode Range Extends beyond Supply Rails** 300mv
- **Push-Pull Output**
- **Offset Voltage:** 0.7mV (TYP)
- **3.5mV Internal Hysteresis**
- **Operating Temperature Range:** -40°C to +125°C
- **Packages:** SOT-23-5L, SOP8, MSOP8, SOP14, TSSOP14

PRODUCT DESCRIPTION

The TS2637 family of products are low-voltage, micro-power CMOS comparators which draw less than 160 μ A per-channel of quiescent current. These devices support rail-to-rail input and output, also the input common-mode range extends beyond the supply rails.

These devices are calibrated to specified at the full temperature range of -40°C to +125°C and operated with a single or dual power supply ranged from 2.7V to 5.5V. The devices have a push-pull output stage that can drive milliampere-level current loads close to the rails.

APPLICATIONS

- RC Timers
- Portable and Battery-Powered Devices
- IR Receivers
- Threshold Detectors and Phase Discriminators
- Rotary Position Encoders
- Zero-Crossing Detectors

PIN CONFIGURATION

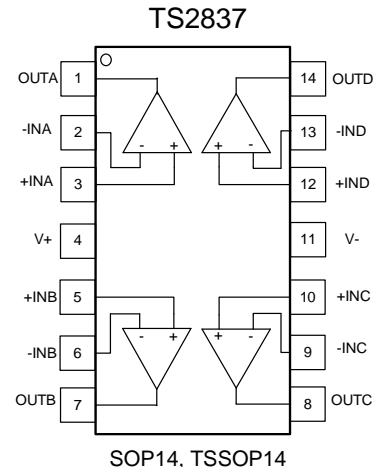
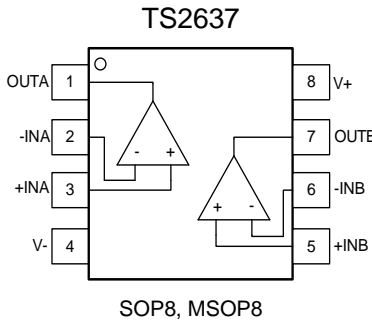
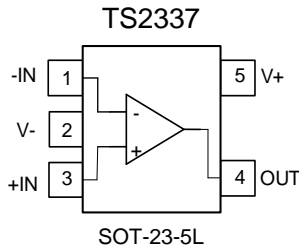

ORDERING INFORMATION

Model	Part Number	Eco Plan	Package	MSL	CMP	Container, Pack Qty
TS2337	TS2337SOT235LR	RoHS	SOT-23-5L	MSL1	1	Reel, 3000
TS2637	TS2637SOP8R	RoHS	SOP8	MSL1	2	Reel, 2500
TS2637	TS2637MSOP8R	RoHS	MSOP8	MSL1	2	Reel, 3000
TS2837	TS2837SOP14R	RoHS	SOP14	MSL1	4	Reel, 2500
TS2837	TS2837TSSOP14R	RoHS	TSSOP14	MSL1	4	Reel, 3000

ABSOLUTE MAXIMUM RATINGS

Over operating free-air temperature range (unless otherwise noted) ⁽¹⁾

Parameter	Min	Max	Unit
Supply Voltage		6	V
Signal Input Terminal Voltage	(V-) -0.3	(V+) +0.3	V
Operating Temperature	-40	150	°C
Junction Temperature		150	°C
Storage Temperature Range	-65	150	°C
Lead Temperature (Soldering, 10s)		260	°C
ESD HBM		±2000	V
ESC CDM		±1500	V

- (1) Stresses beyond those listed under “Absolute Maximum Ratings” may cause permanent damage to the device. This is a stress rating only and functional operation of the device at these or any other conditions beyond those indicated in the operational sections of this specification is not implied. Exposure to absolute maximum rating conditions for extended periods may affect device reliability.

ESD CAUTION



ESD (electrostatic discharge) sensitive device
 Charged devices and circuit boards can discharge without detection. Although this product features patented or proprietary protection circuitry, damage may occur on devices subjects to high energy ESD. Therefore, proper ESD precautions should be taken to avoid performance degradation or loss of functionality.

ELECTRICAL CHARACTERISTICS: $V_S = +2.7V$ to $+5.5V$

Boldface limits apply over the specified temperature range, $T_A = -40^{\circ}C$ to $+125^{\circ}C$.

At $T_A = +25^{\circ}C$, $V_{CM} = V_S / 2$, $R_{Load} = 100k\Omega$, $C_{Load} = 36pF$ (unless otherwise noted)

Parameter	Operating Conditions	Min	Typ	Max	Unit	
V_S Power Supply Voltage		2.7		5.5	V	
I_S Supply Current (per comparator)	$V_S = 5V, I_{OUT} = 0$		160	210	μA	
PSRR Power Supply Rejection Ratio	$V_S = 2.7V$ to $5.5V, V_{CM} = 0$ $T_A = -40^{\circ}C$ to $+125^{\circ}C$		45	200 450	$\mu V/V$ $\mu V/V$	
Input Characteristics						
V_{OS} Input Offset Voltage	$V_S = 5V, V_{CM} = V_S / 2$		0.7	3.5	mV	
$\Delta V_{OS}/\Delta T_A$ Average Drift	$T_A = -40^{\circ}C$ to $+125^{\circ}C$		2		$\mu V/^{\circ}C$	
V_{HYST} Input Hysteresis Voltage	$V_S = 5V, V_{CM} = V_S / 2$		3.5	4	mV	
$\Delta V_{HYST}/\Delta T_A$ Average Drift	$T_A = -40^{\circ}C$ to $+125^{\circ}C$		10		$\mu V/^{\circ}C$	
I_B Input Bias Current			10		pA	
I_{OS} Input Offset Current			10		pA	
CMRR Common Mode Rejection Ratio	$V_S = 5.5V, 0V < V_{CM} < 5.5V$ $T_A = -40^{\circ}C$ to $+125^{\circ}C$	60 58	74		dB dB	
V_{CM} Input Voltage Range		(V-) - 0.3		(V+) + 0.3	V	
Output Characteristics						
V_{OH} Output Voltage High	$V_S = 5V,$ $V_{CM} = 0V$	$I_{OUT} = 2mA$ $T_A = -40^{\circ}C$ to $+125^{\circ}C$	4.8 4.7	4.9	V V	
V_{OL} Output Voltage Low		$I_{OUT} = -2mA$ $T_A = -40^{\circ}C$ to $+125^{\circ}C$		50 100	mV mV	
I_{SC} Short-Circuit Current	$V_S = 5V, Sourcing$ $T_A = -40^{\circ}C$ to $+125^{\circ}C$	37 33	40		mA mA	
	$V_S = 5V, Sinking$ $T_A = -40^{\circ}C$ to $+125^{\circ}C$	40 35	41		mA mA	
Dynamic Performance						
t_R Rise Time	$V_S = 5V,$ Overdrive = 100mV	20% to 80%		13	ns	
t_F Fall Time		80% to 20%		11	ns	
t_{PHL} Propagation Delay (High to Low)	Overdrive = 100mV	$V_S = 5V$ $T_A = -40^{\circ}C$ to $+125^{\circ}C$		80 130	ns ns	
		$V_S = 2.7V$ $T_A = -40^{\circ}C$ to $+125^{\circ}C$		95 150	ns ns	
$V_S = 5V$ $T_A = -40^{\circ}C$ to $+125^{\circ}C$			73 100	88 ns	ns ns	
$V_S = 2.7V$ $T_A = -40^{\circ}C$ to $+125^{\circ}C$			90 115	105 ns	ns ns	
t_{PLH} Propagation Delay (Low to High)						
t_{PDS} Propagation Delay Skew				± 10	ns	
Temperature Range						
θ_{JA}	Specified Range		-40		+125	$^{\circ}C$
	Operating Range		-40		+150	$^{\circ}C$
	Storage Range		-65		+150	$^{\circ}C$
	Thermal Resistance					
	SOT-23-5L			200		$^{\circ}C/W$
	MSOP8, SOP8			150		$^{\circ}C/W$
SOP14, TSSOP14			100		$^{\circ}C/W$	

TYPICAL CHARACTERISTICS

At $T_A = +25^\circ\text{C}$, $V_S = 5\text{V}$, $R_{\text{Load}} = 100\text{k}\Omega$, $C_{\text{Load}} = 36\text{pF}$, and $V_{\text{CM}} = V_S / 2$ (unless otherwise noted)

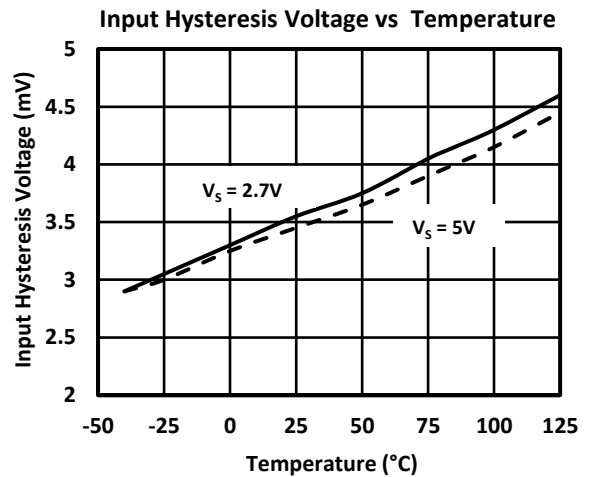
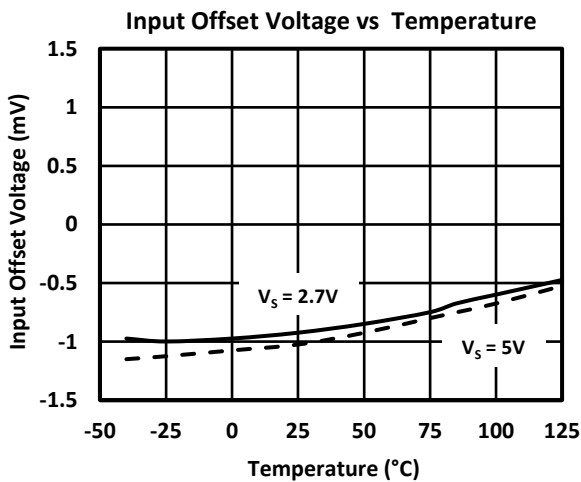
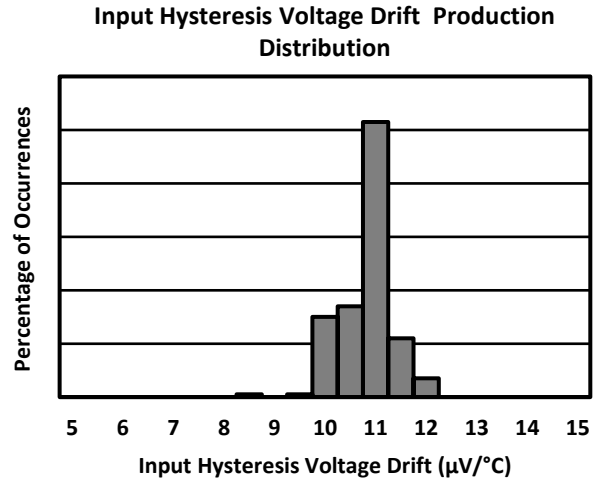
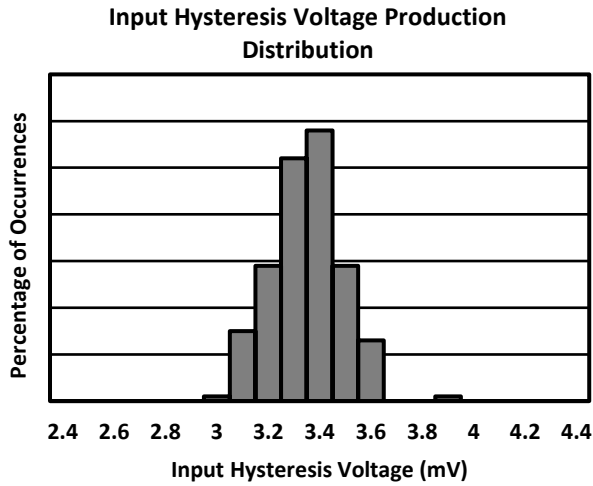
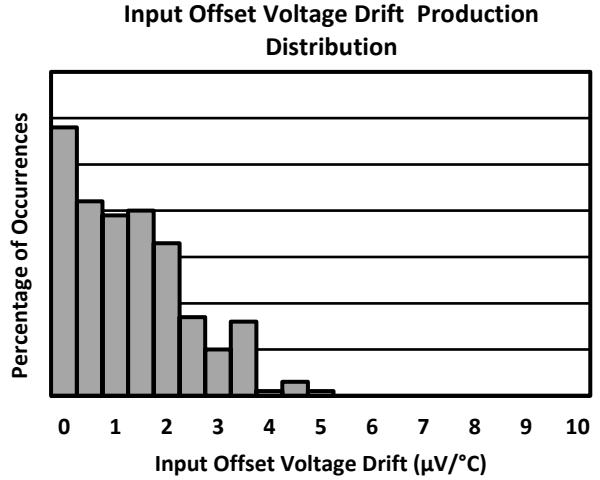
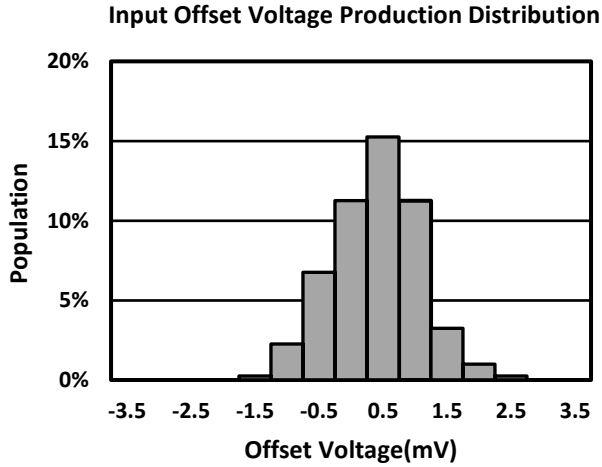

TYPICAL CHARACTERISTICS (CONTINUE)

At $T_A = +25^\circ\text{C}$, $V_S = 5\text{V}$, $R_{\text{Load}} = 100\text{k}\Omega$, $C_{\text{Load}} = 36\text{pF}$, and $V_{\text{CM}} = V_S / 2$ (unless otherwise noted)

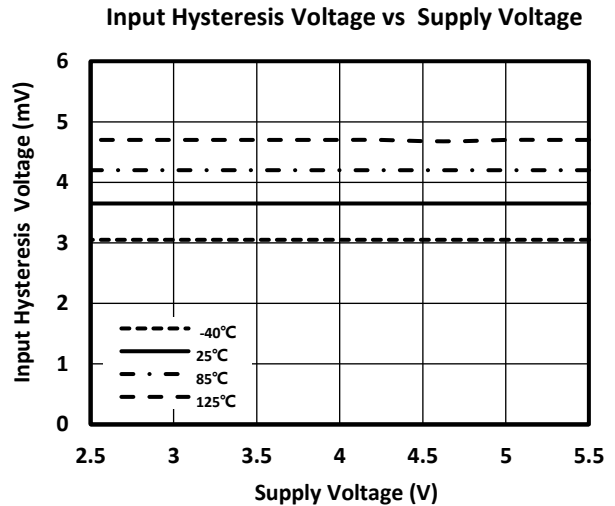
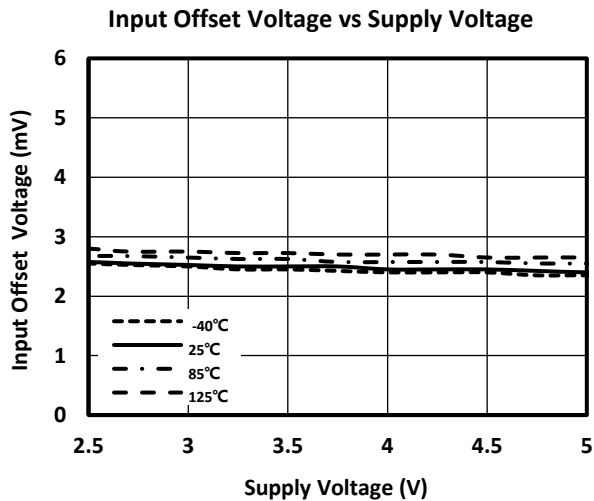
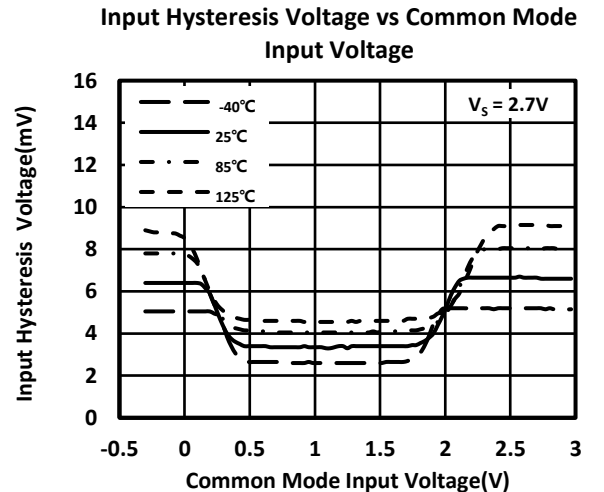
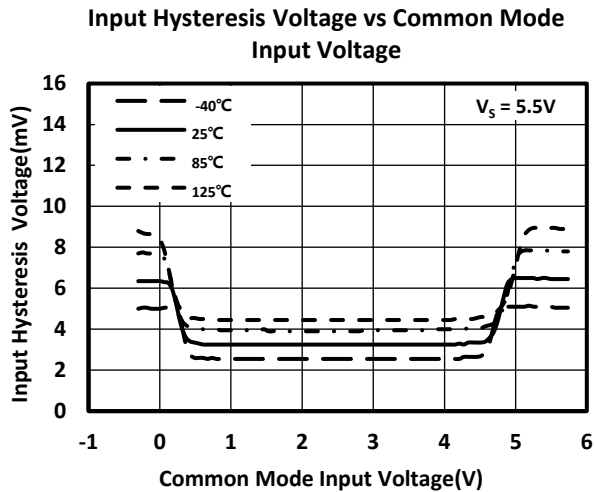
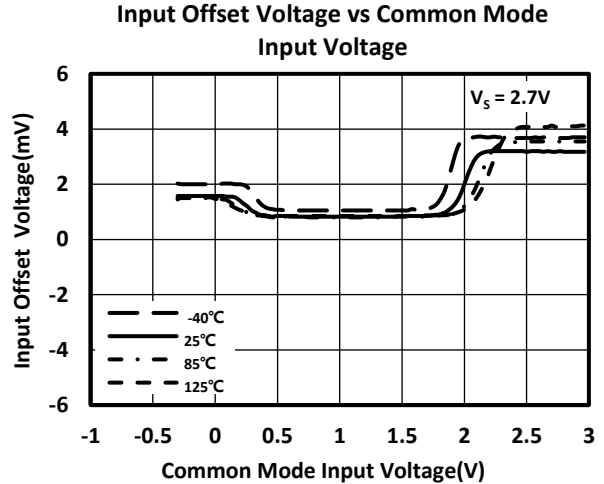
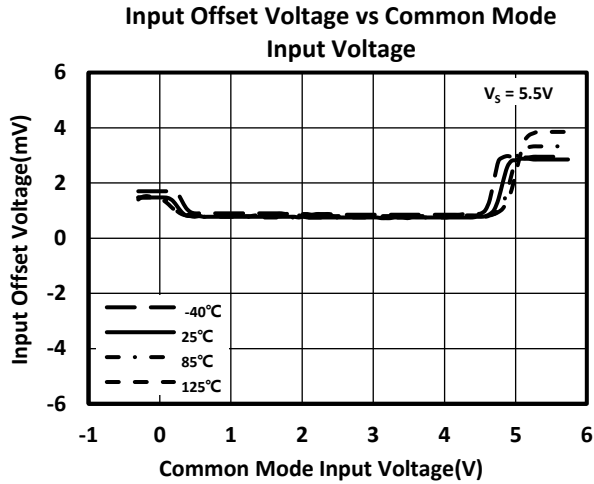

TYPICAL CHARACTERISTICS (CONTINUE)

At $T_A = +25^\circ\text{C}$, $V_S = 5\text{V}$, $R_{\text{Load}} = 100\text{k}\Omega$, $C_{\text{Load}} = 36\text{pF}$, and $V_{\text{CM}} = V_S / 2$ (unless otherwise noted)

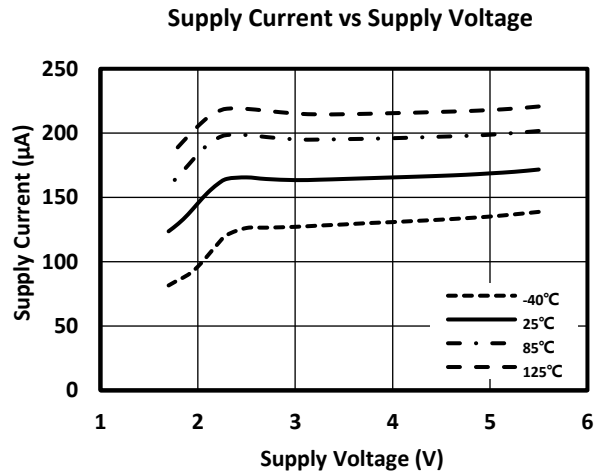
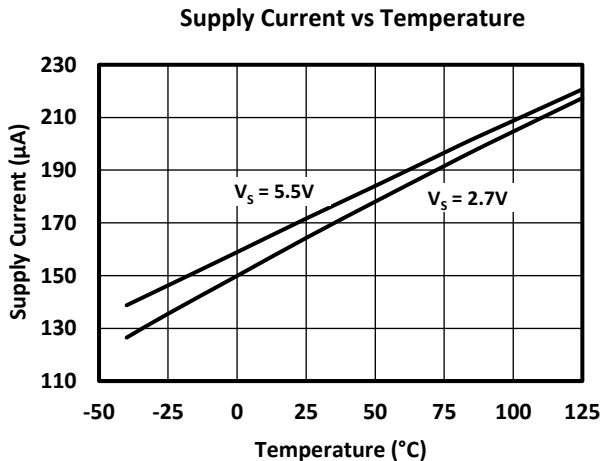
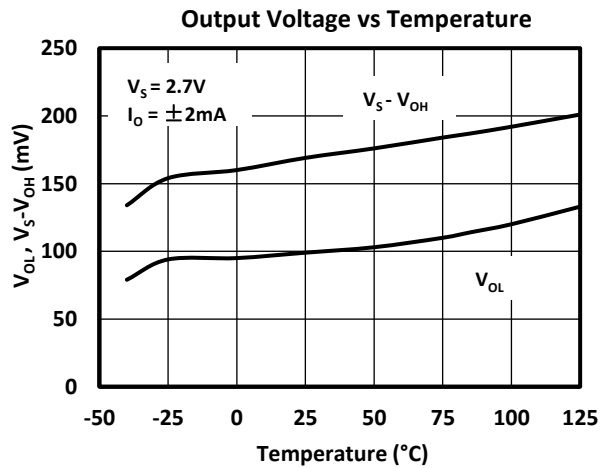
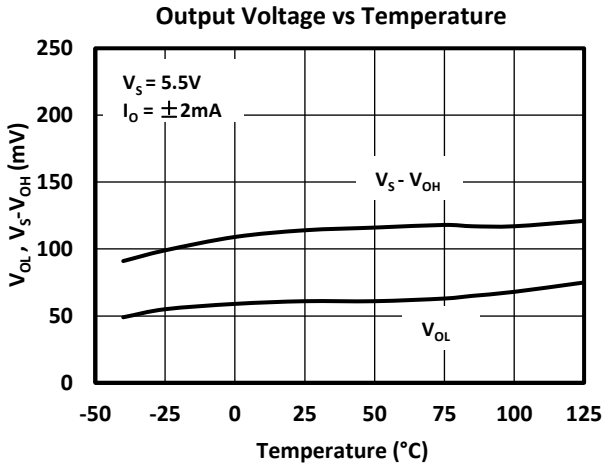
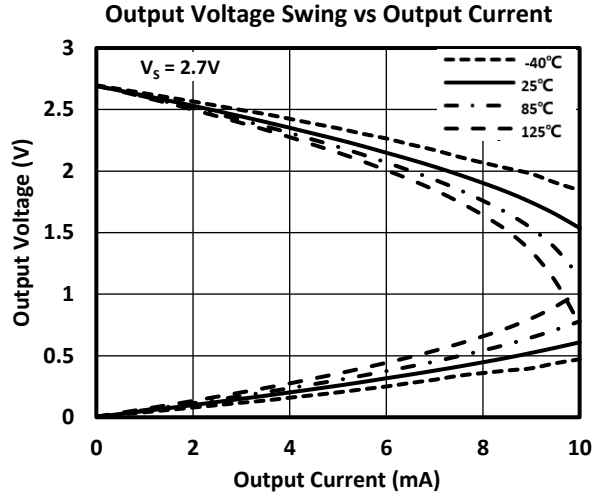
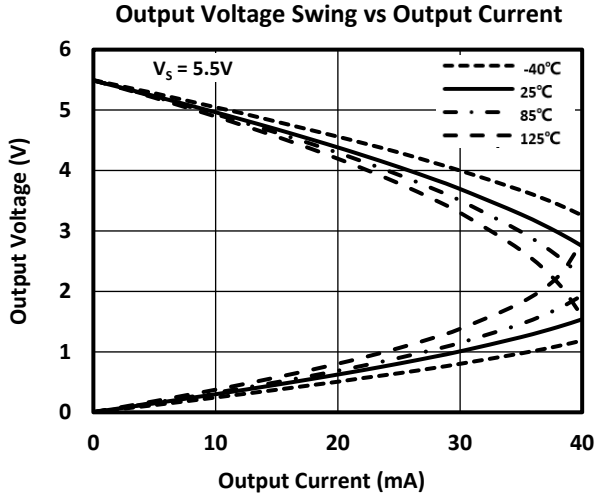

TYPICAL CHARACTERISTICS (CONTINUE)

At $T_A = +25^\circ\text{C}$, $V_S = 5\text{V}$, $R_{\text{Load}} = 100\text{k}\Omega$, $C_{\text{Load}} = 36\text{pF}$, and $V_{\text{CM}} = V_S / 2$ (unless otherwise noted)

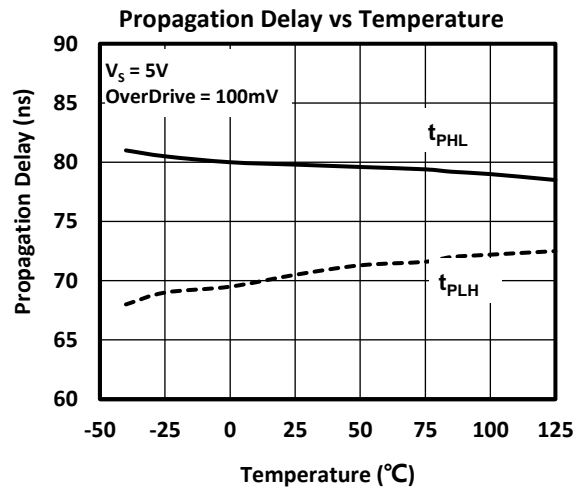
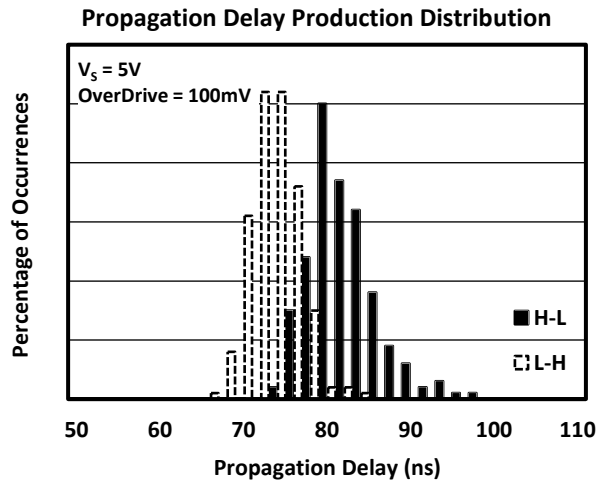
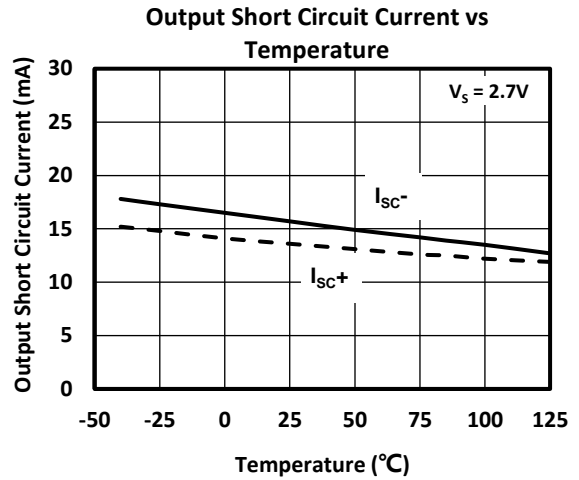
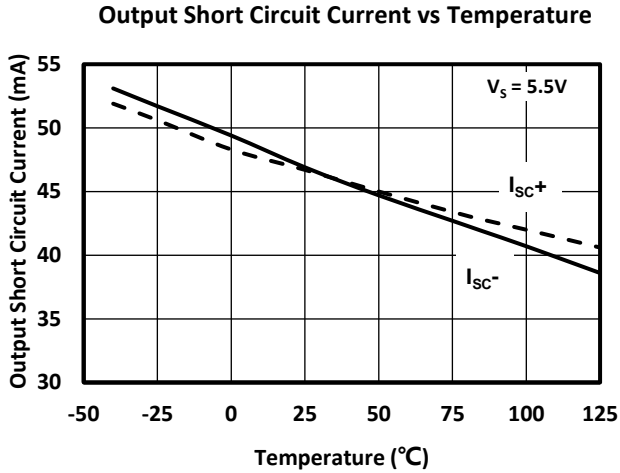

TYPICAL CHARACTERISTICS (CONTINUE)

At $T_A = +25^\circ\text{C}$, $V_S = 5\text{V}$, $R_{\text{Load}} = 100\text{k}\Omega$, $C_{\text{Load}} = 36\text{pF}$, and $V_{\text{CM}} = V_S / 2$ (unless otherwise noted)

Input vs Output Signal No Phase Reversal

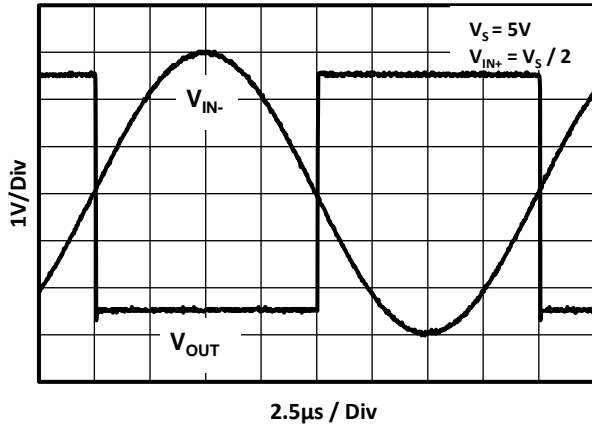

Propagation Delay vs Supply Voltage

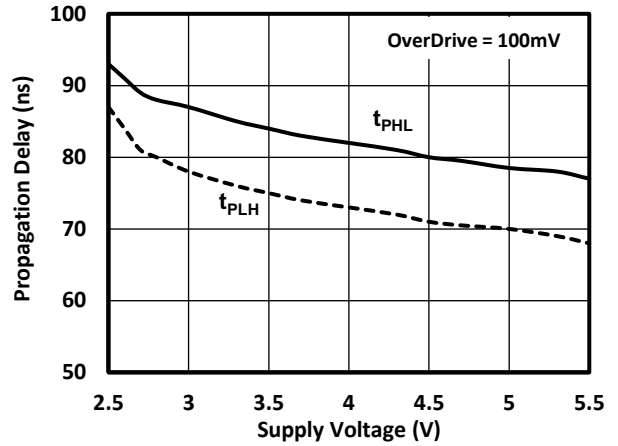

Propagation Delay vs Capacitive Load

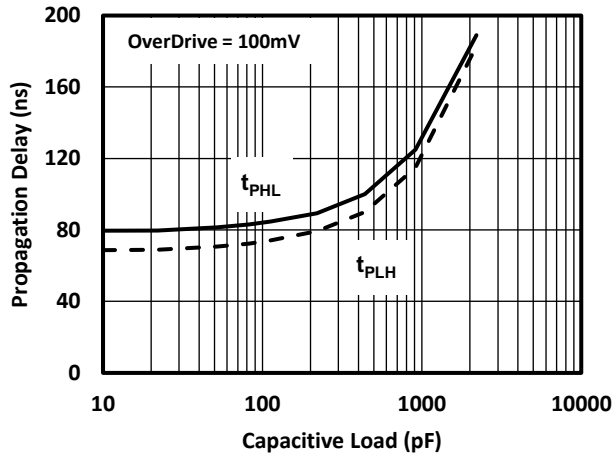

Propagation Delay vs OverDrive

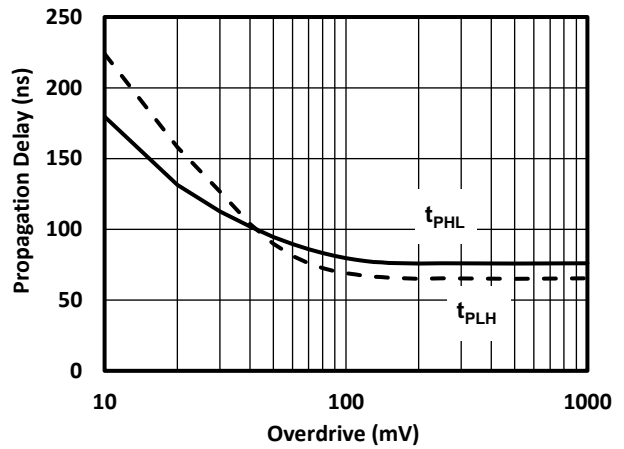

MECHANICAL DIMENSIONS

SOT-23-5L PACKAGE MECHANICAL DRAWING

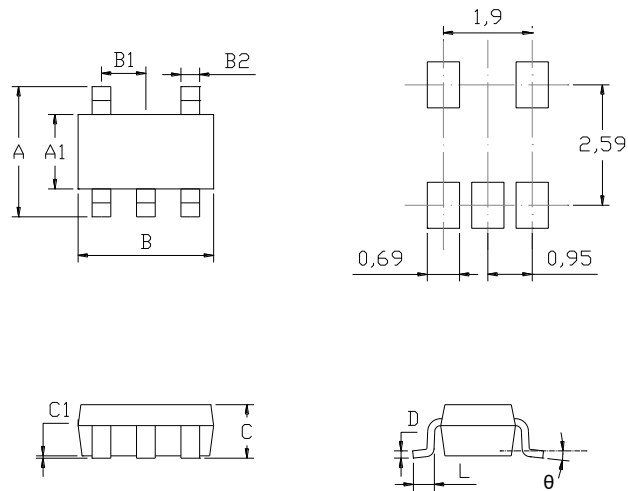

SOT-23-5L PACKAGE MECHANICAL DATA

symbol	dimensions			
	millimeters		inches	
	min	max	min	max
A	2.650	2.950	0.104	0.116
A1	1.500	1.700	0.059	0.067
B	2.820	3.020	0.111	0.119
B1	0.95		0.037	
B2	0.300	0.500	0.012	0.020
C		1.250		0.049
C1	0	0.100	0	0.004
L	0.300	0.600	0.012	0.024
D	0.100	0.200	0.004	0.008
θ	0°	8°	0°	8°

SOP8 PACKAGE MECHANICAL DRAWING

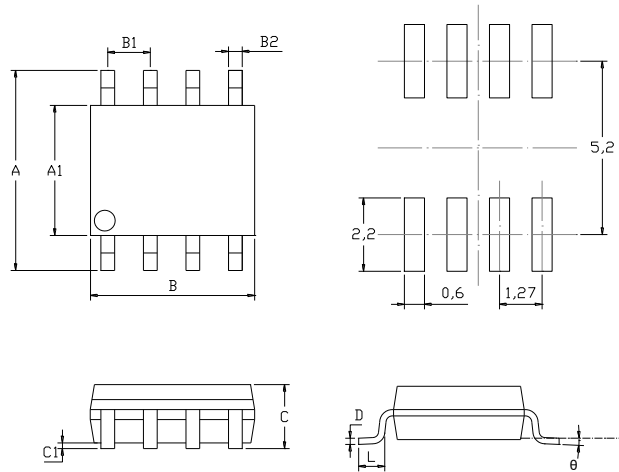

SOP8 PACKAGE MECHANICAL DATA

symbol	dimensions			
	millimeters		inches	
	min	max	min	max
A	5.800	6.200	0.228	0.244
A1	3.800	4.000	0.150	0.157
B	4.700	5.100	0.185	0.201
B1	1.270		0.050	
B2	0.330	0.510	0.013	0.020
C		1.750		0.069
C1	0.100	0.250	0.004	0.010
L	0.400	1.270	0.016	0.050
D	0.170	0.250	0.007	0.010
θ	0°	8°	0°	8°

MSOP8 PACKAGE MECHANICAL DRAWING

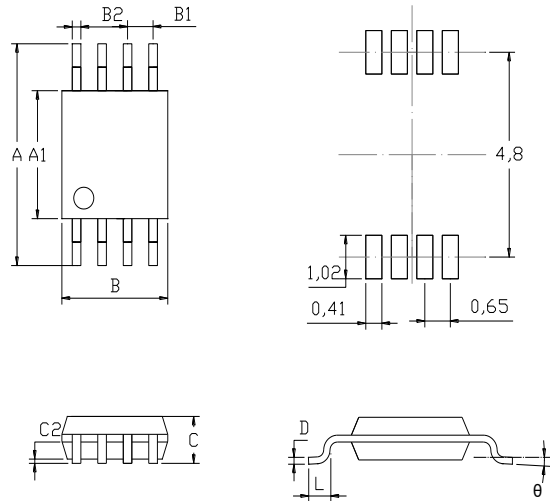

MSOP8 PACKAGE MECHANICAL SPECIFICATIONS

symbol	dimensions			
	millimeters		inches	
	min	max	min	max
A	4.750	5.050	0.187	0.199
A1	2.900	3.100	0.114	0.122
B	2.900	3.100	0.114	0.122
B1	0.650		0.026	
B2	0.250	0.380	0.010	0.015
C	0.820	1.100	0.032	0.043
C2	0.020	0.150	0.001	0.006
L	0.400	0.800	0.016	0.031
D	0.090	0.230	0.004	0.009
θ	0°	6°	0°	6°

SOP14 PACKAGE MECHANICAL DRAWING

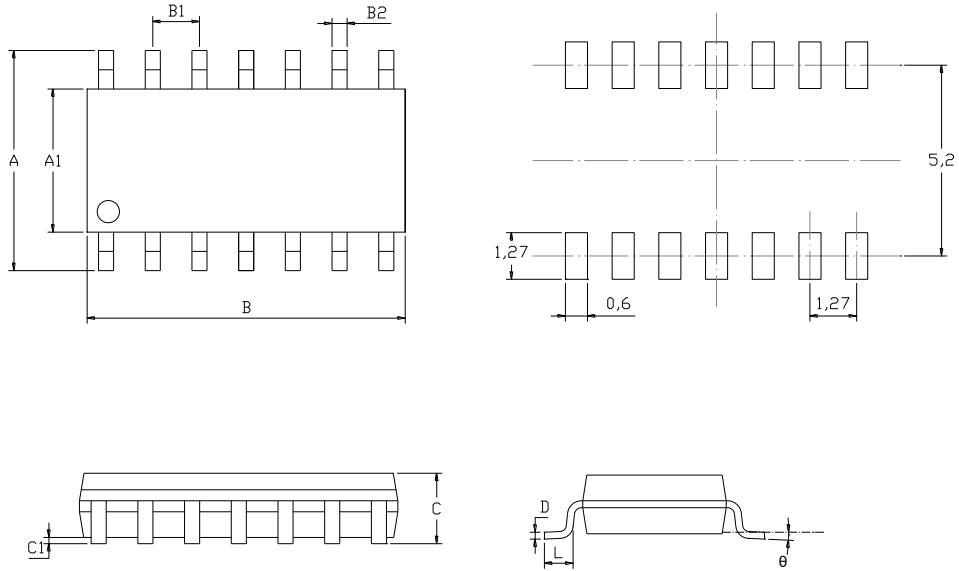

SOP14 PACKAGE MECHANICAL DATA

symbol	dimensions			
	millimeters		inches	
	min	max	min	max
A	5.800	6.200	0.228	0.244
A1	3.800	4.000	0.150	0.157
B	8.450	8.850	0.333	0.348
B1	1.270		0.050	
B2	0.310	0.510	0.012	0.020
C		1.750		0.069
C1	0.100	0.250	0.004	0.010
L	0.400	1.270	0.016	0.050
D	0.100	0.250	0.004	0.010
θ	0°	8°	0°	8°

TSSOP14 PACKAGE MECHANICAL DRAWING

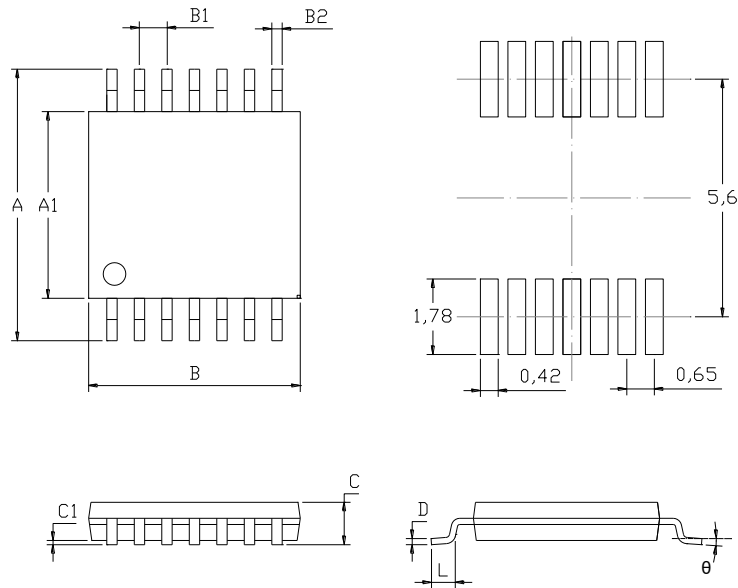

TSSOP14 PACKAGE MECHANICAL DATA

symbol	dimensions			
	millimeters		inches	
	min	max	min	max
A	6.250	6.550	0.246	0.258
A1	4.300	4.500	0.169	0.177
B	4.900	5.100	0.193	0.201
B1	0.650		0.026	
B2	0.190	0.300	0.007	0.012
C		1.200		0.047
C1	0.050	0.150	0.002	0.006
L	0.500	0.700	0.020	0.028
D	0.090	0.200	0.004	0.008
θ	1°	7°	1°	7°

TAPE AND REEL INFORMATION

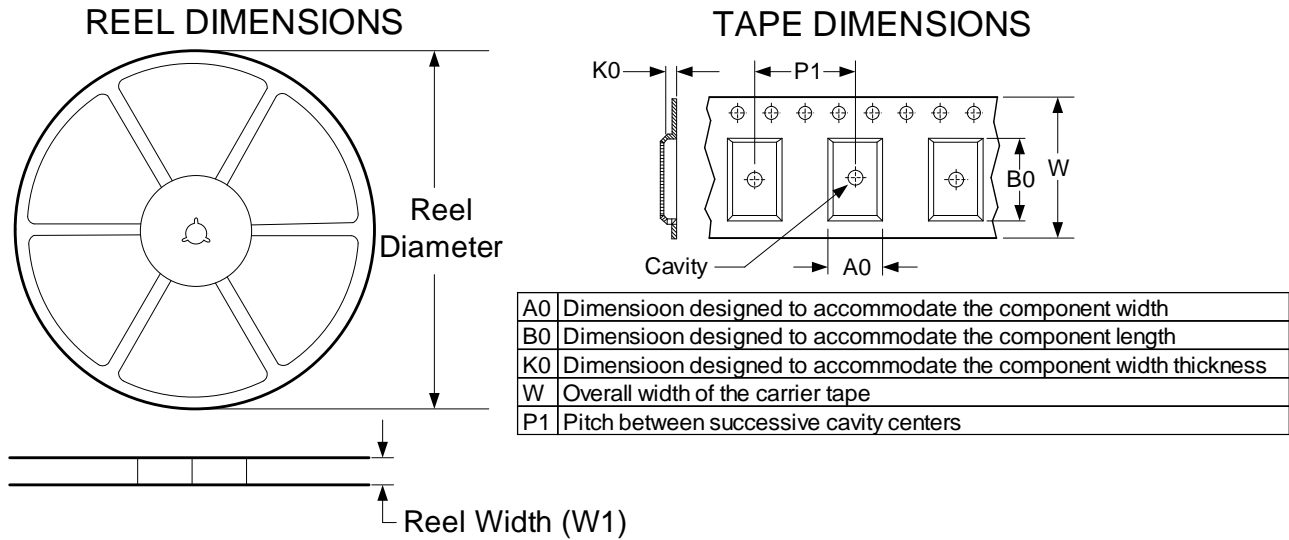

QUADRANT ASSIGNMENTS FOR PIN 1 ORIENTATION IN TAPE

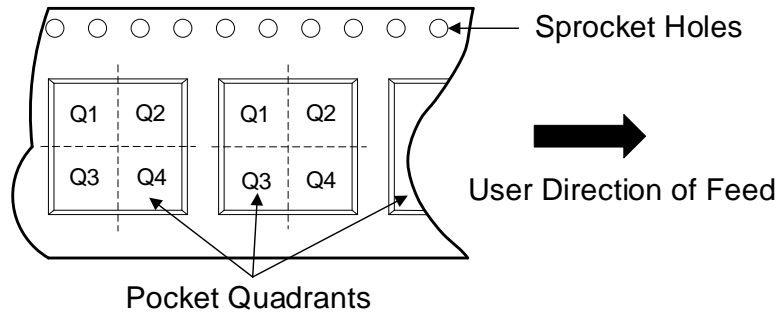

Device	Package Type	Pins	SPQ	Reel Diameter (mm)	Reel Width W1 (mm)	A0 (mm)	B0 (mm)	K0 (mm)	P1 (mm)	W (mm)	Pin1 Quadrant
TS2337SOT235LR	SOT-23-5L	5	3000	180.0	9.0	3.2	3.3	1.4	4.0	8.0	Q3
TS2637SOP8R	SOP8	8	2500	330.0	12.4	6.4	5.4	2.1	8.0	12.0	Q1
TS2637MSOP8R	MSOP8	8	3000	330.0	12.4	5.2	3.3	1.5	8.0	12.0	Q1
TS2837SOP14R	SOP14	14	2500	330.0	12.4	6.5	9.0	2.1	8.0	16.0	Q1
TS2837TSSOP14R	TSSOP14	14	3000	330.0	12.4	6.8	5.4	1.2	8.0	12.0	Q1

REVISION HISTORY

NOTE: Page numbers for previous revisions may be different from that of the current version.

2020/8/20 — REV KY1.1.1B to REV KY1.1.2B

Added notice to ABSOLUTE MAXIMUM RATINGS2
Updated the format of ELECTRICAL CHARACTERISTICS3

2020/10/29 — REV KY1.1.2B to REV KY1.1.3B

Added MSL to ORDERING INFORMATION2

2020/11/26 — REV KY1.1.3B to REV KY1.1.4B

Updated chip pin definition.....1

2021/07/13 — REV KY1.1.4B to REV KY1.2.4B

Updated TSSOP14 SPQ.....2,14

CONTACT INFORMATION

Trusignal Microelectronics

Phone: +86 512-65923982

Fax: +86 512-65923995

Email: support@trusignal.com; sales@trusignal.com