

1MHz, Rail-to-Rail I/O CMOS Operational Amplifiers

FEATURES

- RAIL-TO-RAIL INPUT/OUTPUT
- HIGH SLEW RATE: 0.8V/ μ s
- LOW INPUT BIAS CURRENT: 10pA typ at 25°C
- GAIN BANDWIDTH PRODUCT: 1 MHz
- LOW OFFSET VOLTAGE DRIFT: 3 μ V/ $^{\circ}$ C typ
- LOW POWER CONSUMPTION: 90 μ A per amplifier at 5 V
- LOW SUPPLY VOLTAGE: 2.5 V ~ 5.5 V (25°C)
- EXTENDED TEMPERATURE: -40°C to +125°C

APPLICATIONS

- BATTERY-POWERED APPLICATIONS
- PORTABLE DEVICES
- SIGNAL CONDITIONING
- ACTIVE FILTERING
- CURRENT SENSOR AMPLIFIER
- WEIGHT SCALE SENSOR
- MEDICAL/ INDUSTRIAL INSTRUMENTATION
- INSTRUMENTATION

PIN ASSIGNMENTS

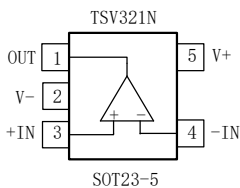
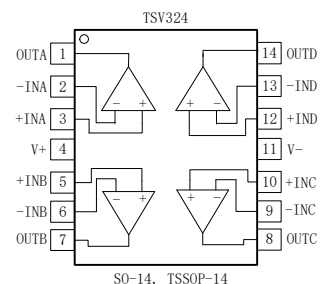
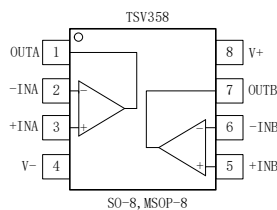
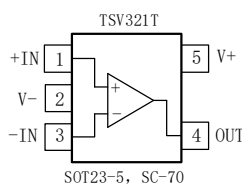

GENERAL DESCRIPTION

TSV321/TSV358/TSV324 are the most cost-effective amplifiers for low voltage, low power consumption and low-cost applications. The rail-to-rail output and rail-to-rail inputs that exceed power supply range make the TSV321 series easy to use for very low voltage supply applications.

Low I_B feature of these amplifiers allows the parts to be ideal for many sensor applications. 1MHz GBW and 0.8V/ μ s slew rate under low power supply voltage can meet almost all sensor requirement.

Small Packages:

TSV321 in a SOT23-5 and SC70-5

TSV358 in a SO8 and MSOP8

TSV324 in a SO14 and TSSOP14

ORDERING INFORMATION

Model	Part Number	Eco Plan	Package	AMP	Container, Pack Qty
TSV321	TSV321SOT235R	Rohs	SOT23-5	1	Reel, 3000
TSV321	TSV321SC705R	Rohs	SC70-5	1	Reel, 3000
TSV358	TSV358SO8R	Rohs	SO-8	2	Reel, 2500
TSV358	TSV358MSOP8R	Rohs	MSOP-8	2	Reel, 3000
TSV324	TSV324SO14R	Rohs	SO-14	4	Reel, 2500
TSV324	TSV324TSSOP14R	Rohs	TSSOP-14	4	Reel, 3000

ABSOLUTE MAXIMUM RATINGS

Parameter	Min	Max	Unit
Supply Voltage		7.0	V
Signal Input Terminal Voltage	(V-) - 0.5	(V+) + 0.5	V
Operating Temperature	-50	150	°C
Junction Temperature		150	°C
Storage Temperature	-65	150	°C
Lead Temperature (Soldering, 10s)		260	°C
ESD HBM		±3000	V
ESD MM		±400	V
ESC CDM		±1000	V

ESD CAUTION



ESD (Electrostatic Discharge) sensitive device. Charged devices and circuit boards can discharge without detection. Although this product features patented or proprietary protection circuitry, damage may occur on devices subjects to high energy ESD. Therefore, proper ESD precautions should be taken to avoid performance degradation or loss of functionality.

ELECTRICAL CHARACTERISTICS

$V_S = +2.5V$ to $+5.5V$, at $T_A = +25^\circ C$, $R_L = 100k\Omega$ connected to $V_S/2$, and $V_{OUT} = V_S/2$, unless otherwise noted.

Boldface limits apply over the specified temperature range, $T_A = -40^\circ C$ to $+125^\circ C$.

Symbol	Parameter	Operating Conditions	Min	Typ	Max	Unit
Input Characteristics						
V_{OS} dV_{OS}/dT	Input Offset Voltage Drift	$V_S = 5V$		1.2 3	5	mV $\mu V/^\circ C$
CMRR	Common Mode Rejection Ratio $T_A = -40^\circ C$ to $+125^\circ C$ $T_A = -40^\circ C$ to $+125^\circ C$	$(V_-) - 0.2V < V_{CM} < (V_+) - 2V$ $(V_-) - 0.2V < V_{CM} < (V_+) - 2V$ $V_S = 5.5V, (V_-) - 0.2V < V_{CM} < (V_+) + 0.2V$ $V_S = 5.5V, (V_-) - 0.2V < V_{CM} < (V_+) + 0.2V$	73 65 57 56	84 70		dB dB dB dB
I_B I_{OS}	Input Bias Current Input Offset Current			10 10		pA pA
PSRR	Power Supply Rejection Ratio $T_A = -40^\circ C$ to $+125^\circ C$	$V_S = 2.5V$ to $V_S = 5.5V, V_{CM} < (V_+) - 2V$	66 63	87		dB dB
A_{OL}	Open-Loop Gain $T_A = -40^\circ C$ to $+125^\circ C$ Open-Loop Gain $T_A = -40^\circ C$ to $+125^\circ C$	$V_S = 5V, R_L = 5k\Omega, 0.125V < V_O < 4.875V$ $V_S = 5V, R_L = 5k\Omega, 0.125V < V_O < 4.875V$ $V_S = 5V, R_L = 100k\Omega, 0.025V < V_O < 4.975V$ $V_S = 5V, R_L = 100k\Omega, 0.025V < V_O < 4.975V$	86 70 95 76	100 108		dB dB dB dB
Output Characteristics						
	Output Voltage Swing from Rail	$R_L = 100k\Omega$		10		mV
R_{OUT}	Open-Loop Output Impedance	$f = 1MHz, I_o = 0$		280		Ω
Frequency Domain Response						
GBW	Gain Bandwidth Product	$V_{OUT} = 2V$ step; $G = +1$ $V_{in} * Gain > V_S$ $G = +1$		1		MHz
t_s	Settling Time to 0.1%			3		μs
SR	Overload recovery time Slew Rate			1 0.8		μs $V/\mu s$
Power Supply						
V_S	Specified Voltage Range Operating Voltage Range		2.5 2.2		5.5 5.5	V V
I_S	Supply Current	$I_o = 0, V_S = 5V$		90	140	μA
Temperature Range						
θ_{JA}	Specified Range Thermal Resistance SO-8		-40		125	$^\circ C$ $^\circ C/W$

TYPICAL CHARACTERISTICS

At $T_A = +25^\circ\text{C}$, $R_L = 10\text{k}\Omega$ connected to $V_S/2$, and $V_{OUT} = V_S/2$, unless otherwise noted.

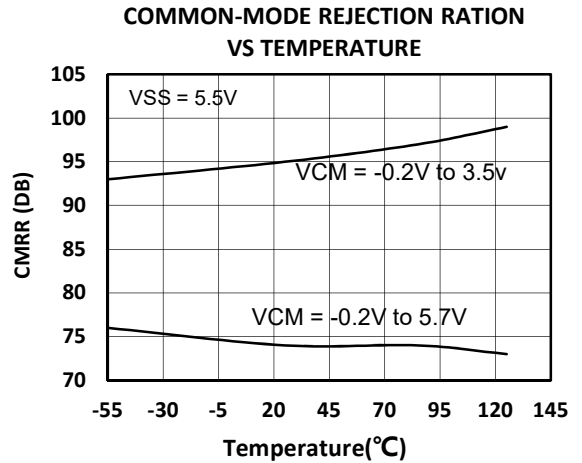
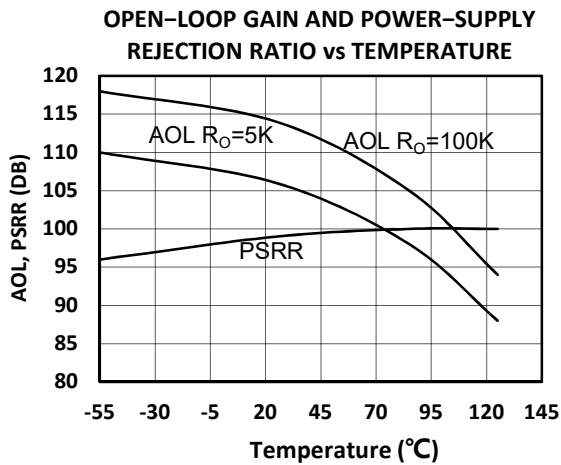
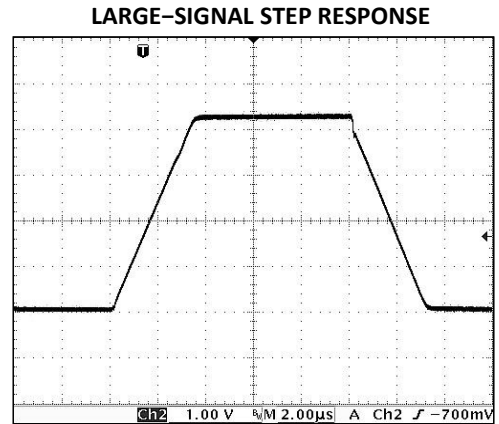
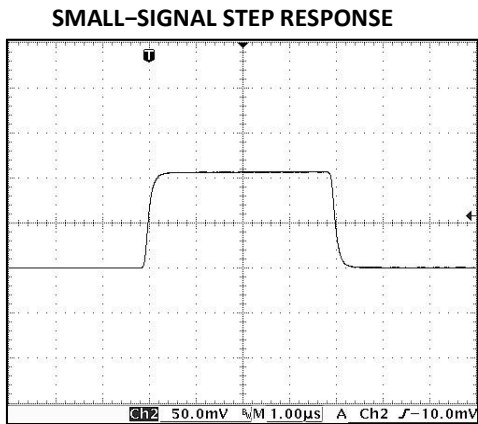
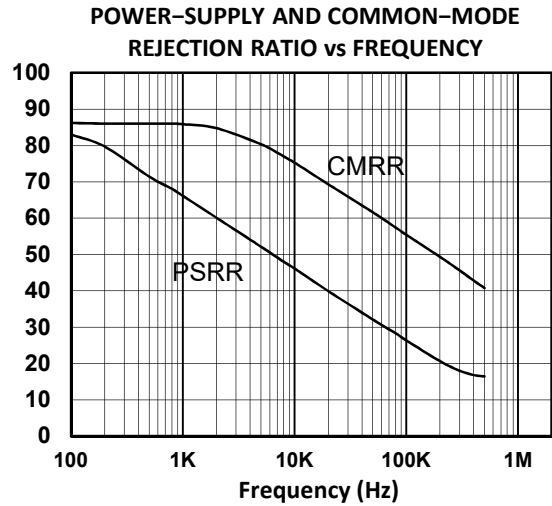
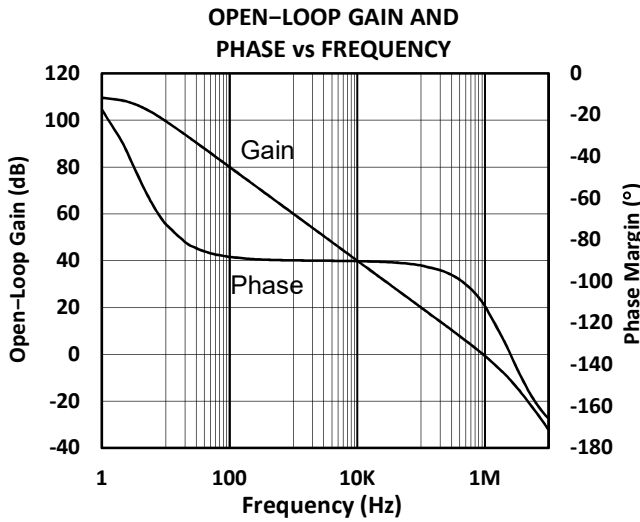

TYPICAL CHARACTERISTICS

At $T_A = +25^\circ\text{C}$, $R_L = 10\text{k}\Omega$ connected to $V_s/2$, and $V_{OUT} = V_s/2$, unless otherwise noted.

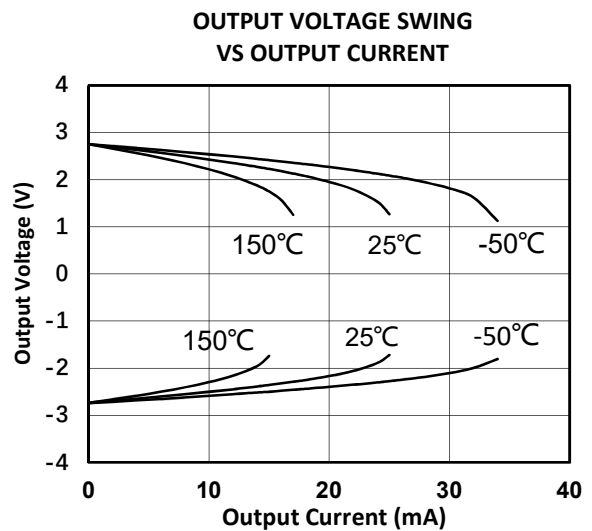
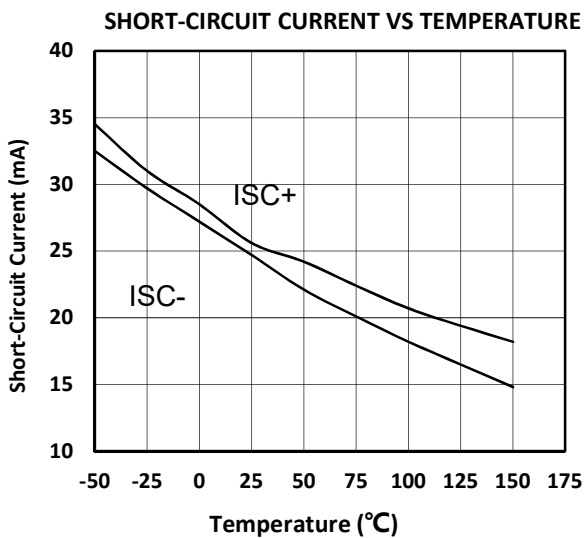
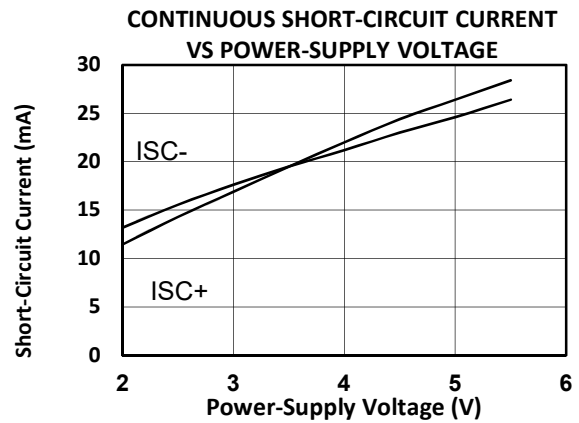
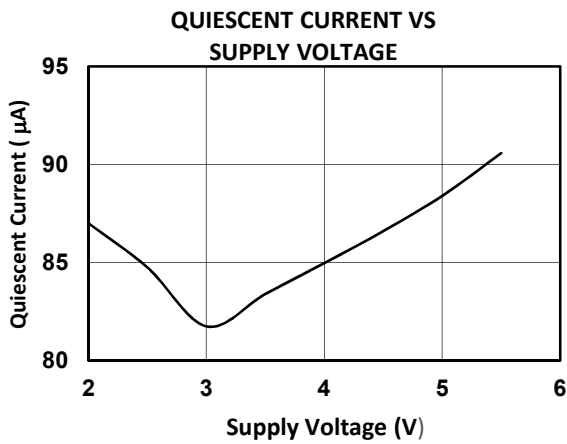
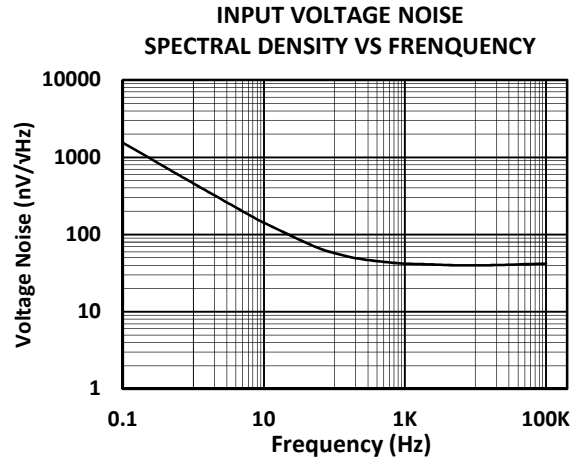
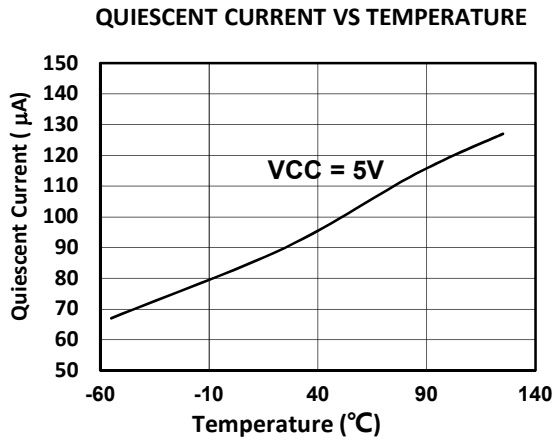

TYPICAL CHARACTERISTICS

At $T_A = +25^\circ\text{C}$, $R_L = 10\text{k}\Omega$ connected to $V_S/2$, and $V_{OUT} = V_S/2$, unless otherwise noted.

Offset Voltage Production Distribution

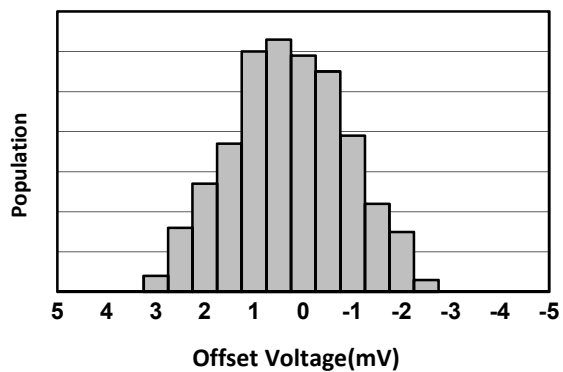

Offset Voltage Drift Magnitude Production Distribution

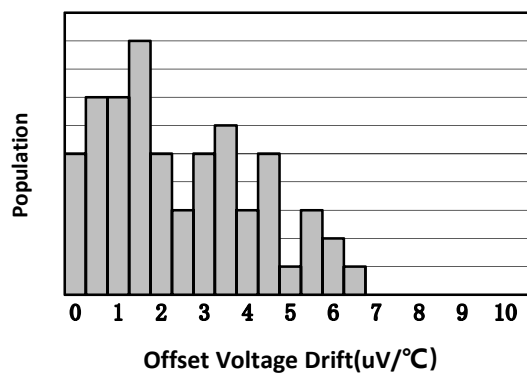

MECHANICAL DIMENSIONS

SOT23-5 PACKAGE MECHANICAL DRAWING

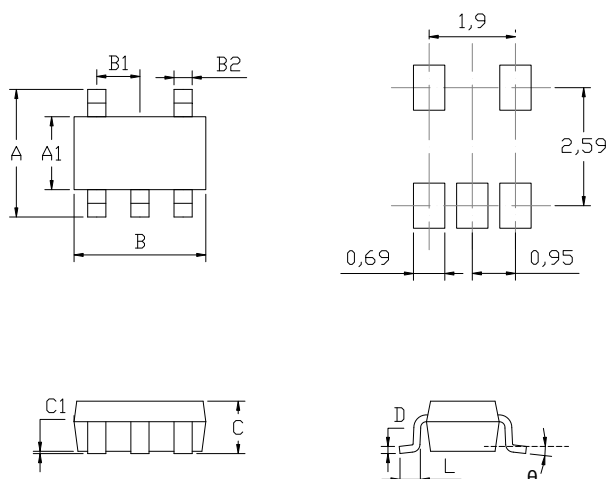

SOT23-5 PACKAGE MECHANICAL SPECIFICATIONS

symbol	dimensions			
	millimeters		inches	
	min	max	min	max
A	2.650	2.950	0.104	0.116
A1	1.500	1.700	0.059	0.067
B	2.820	3.020	0.111	0.119
B1	0.950		0.037	
B2	0.300	0.500	0.012	0.020
C	1.050	1.250	0.041	0.049
C1	--	0.100	--	0.004
L	0.300	0.600	0.012	0.024
D	0.100	0.200	0.004	0.008
θ	0°	8°	0°	8°

SC70-5 PACKAGE MECHANICAL DRAWING

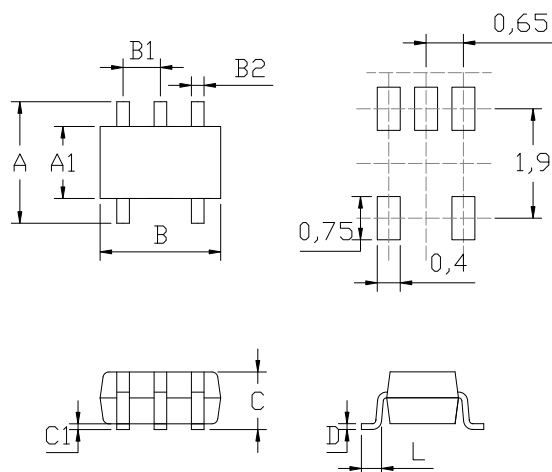

SC70-5 PACKAGE MECHANICAL SPECIFICATIONS

symbol	dimensions			
	millimeters		inches	
	min	max	min	max
A	2.150	2.450	0.085	0.096
A1	1.150	1.350	0.045	0.053
B	2.000	2.200	0.079	0.087
B1	0.650		0.026	
B2	0.150	0.350	0.006	0.014
C	0.900	1.100	0.035	0.043
C1	--	0.100	--	0.004
L	0.260	0.460	0.010	0.018
D	0.080	0.150	0.003	0.0087
θ	0°	8°	0°	8°

MSOP-8 PACKAGE MECHANICAL DRAWING

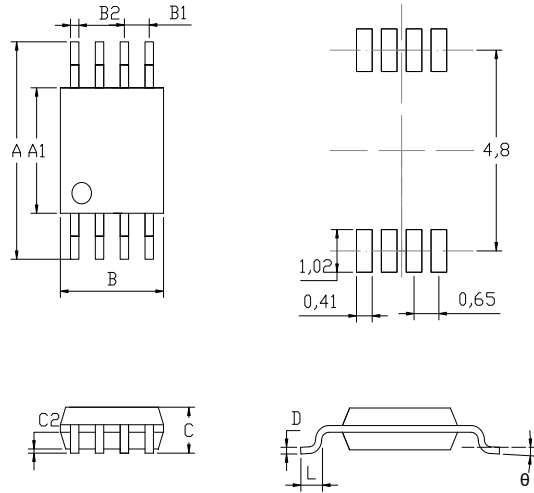

MSOP-8 PACKAGE MECHANICAL SPECIFICATIONS

symbol	dimensions			
	millimeters		inches	
	min	max	min	max
A	4.750	5.050	0.187	0.199
A1	2.900	3.100	0.114	0.122
B	2.900	3.100	0.114	0.122
B1	0.650		0.026	
B2	0.250	0.380	0.010	0.015
C	0.820	1.100	0.032	0.043
C2	0.020	0.150	0.001	0.006
L	0.400	0.800	0.016	0.031
D	0.090	0.230	0.004	0.009
θ	0°	6°	0°	6°

TSSOP-14 PACKAGE MECHANICAL DRAWING

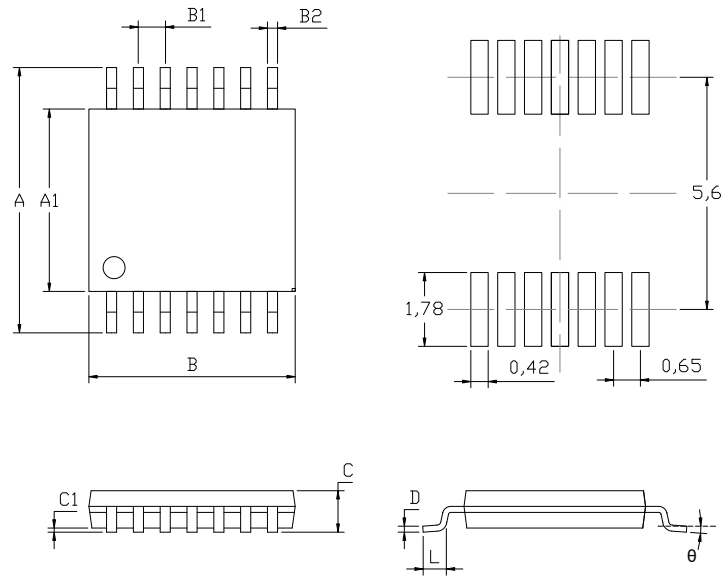

TSSOP-14 PACKAGE MECHANICAL SPECIFICATIONS

symbol	dimensions			
	millimeters		inches	
	min	max	min	max
A	6.250	6.550	0.246	0.258
A1	4.300	4.500	0.169	0.177
B	4.900	5.100	0.193	0.201
B1	0.650		0.026	
B2	0.190	0.300	0.007	0.012
C	--	1.200	--	0.047
C1	0.050	0.150	0.002	0.006
L	0.500	0.700	0.020	0.028
D	0.090	0.200	0.004	0.008
θ	0°	7°	0°	7°

SO-8 PACKAGE MECHANICAL DRAWING

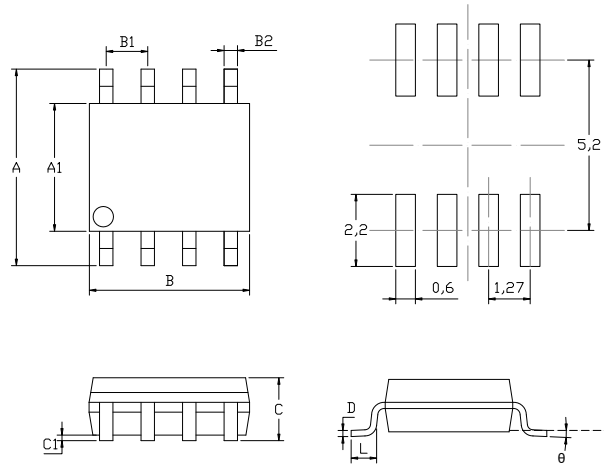

SO-8 PACKAGE MECHANICAL SPECIFICATIONS

symbol	dimensions			
	millimeters		inches	
	min	max	min	max
A	5.800	6.200	0.228	0.244
A1	3.800	4.000	0.150	0.157
B	4.700	5.100	0.185	0.201
B1	1.270		0.050	
B2	0.330	0.510	0.013	0.020
C	1.350	1.750	0.053	0.069
C1	0.100	0.250	0.004	0.010
L	0.400	1.270	0.016	0.050
D	0.170	0.250	0.007	0.010
θ	0°	8°	0°	8°

SO-14 PACKAGE MECHANICAL DRAWING

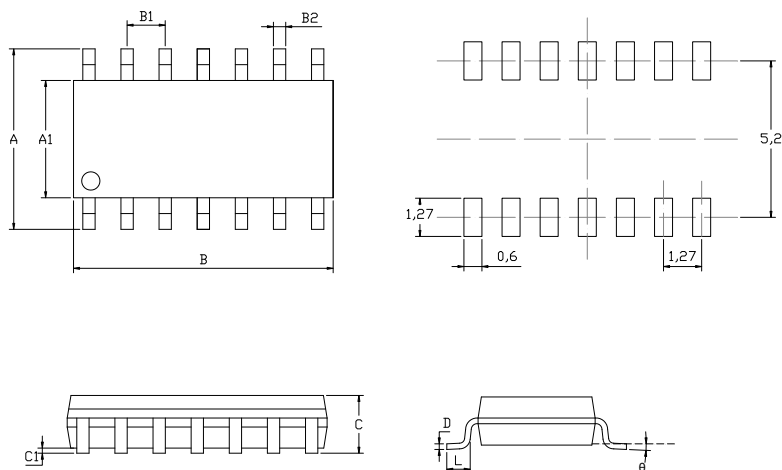

SO-14 PACKAGE MECHANICAL SPECIFICATIONS

symbol	dimensions			
	millimeters		inches	
	min	max	min	max
A	5.800	6.200	0.228	0.244
A1	3.800	4.000	0.150	0.157
B	8.450	8.850	0.333	0.348
B1	1.270		0.050	
B2	0.310	0.510	0.012	0.020
C	--	1.750	--	0.069
C1	0.100	0.250	0.004	0.010
L	0.400	1.270	0.016	0.050
D	0.100	0.250	0.004	0.010
θ	0°	8°	0°	8°

CONTACT INFORMATION

Trusignal Microelectronics

Phone: +86 512-65923982

Fax: +86 512-65923995

Email: sales@kunyuanic.com

support@kunyuanic.com